

Article number: 021816011163

Description: Clamp with bracket and rubber
SPGU 6011. 163/30 SK

Measures

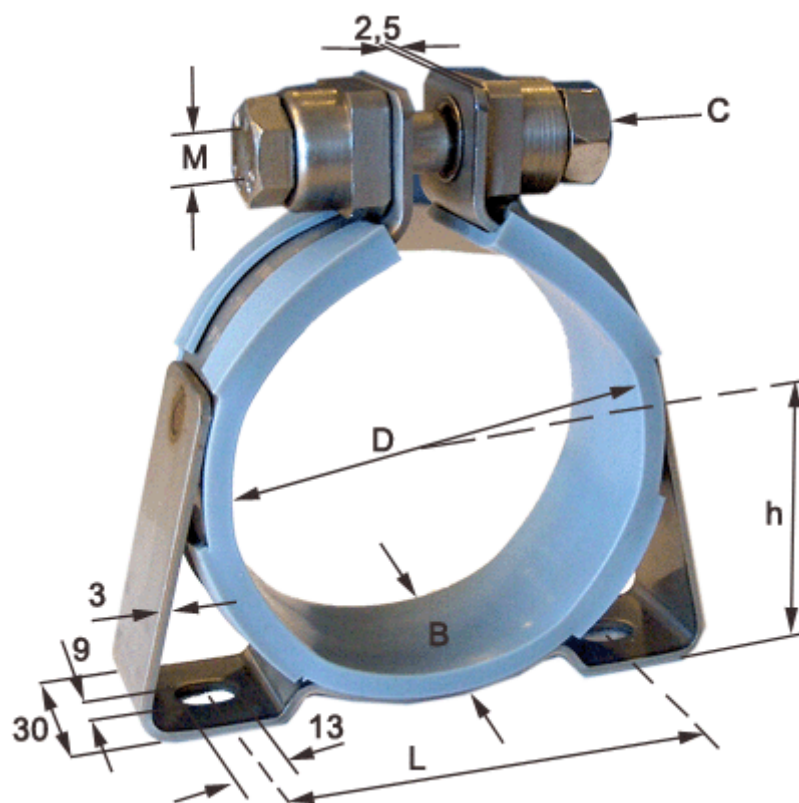

C (screw type) = SK hexagon screw

Diameter D = 163

h = 90

L = 148

Width B = 30